

# DOP-201

## Degree of Polarization Meter

---



---

## User Guide

Version: 1.0  
Date: November 27, 2017

**General Photonics Corporation is located in Chino California.**

**For more information visit the company's website at:**

**[www.generalphotonics.com](http://www.generalphotonics.com)**

**or call 909-590-5473**

### SAFETY CONSIDERATIONS

The following safety precautions must be observed during operation of this product. Failure to comply with these precautions or with specific warnings elsewhere in this manual violates safety standards of design, manufacture, and intended use of the product. General Photonics assumes no liability for customers' failure to comply with these requirements.

**Before operation, the user should inspect the product and review the manual carefully.**

Properly ground the chassis and work space using the chassis ground terminal.

Use only in a safe work environment in terms of temperature, humidity, electrical power and risk of fire or shock. The product is designed for indoor use. Avoid exposure to liquids or water condensation. Provide adequate ventilation for cooling.

Operate the product on a stable surface. Avoid excess vibration.

Standard laser safety procedures should be followed during operation.

***Never look into the light source fiber connector when the light source is turned on. THE OUTPUT LIGHT FROM A HIGH POWER LASER IS HARMFUL TO HUMAN EYES. Follow industry standard procedures when operating a high power laser source.***



<b>Section 1.0</b>	<b>Overview .....</b>	<b>7</b>
1.1	Principle of Operation .....	7
<b>Section 2.0</b>	<b>Features .....</b>	<b>9</b>
2.1	Front Panel and Optical Inputs .....	9
	<u>Fiber Connectors</u> .....	<u>10</u>
	<u>Ferrule Cleaning Procedure</u> .....	<u>10</u>
2.2	Rear Panel: Electrical and Remote Control Interfaces .....	11
<b>Section 3.0</b>	<b>Operation Instructions .....</b>	<b>13</b>
3.1	Unpacking .....	13
3.2	Front Panel Operation .....	13
3.3	Operation Modes .....	15
	<u>DOP/Power measurement</u> .....	<u>15</u>
	<u>Signal to Noise Ratio (SNR) Measurement</u> .....	<u>16</u>
	<u>Noise Figure (NF) Measurement</u> .....	<u>16</u>
	<u>Setup</u> .....	<u>17</u>
3.4	Troubleshooting .....	25
	<u>General Guidelines</u> .....	<u>25</u>
	<u>Remote Control</u> .....	<u>25</u>
<b>Section 4.0</b>	<b>Specifications .....</b>	<b>27</b>
	<u>Optical</u> .....	<u>27</u>
	<u>Electrical/Communication</u> .....	<u>27</u>
	<u>Physical and Environmental</u> .....	<u>27</u>
<b>Appendices .....</b>		<b>29</b>
<b>Appendix 1.0</b>	<b>Remote Control Commands .....</b>	<b>29</b>
	<u>Command Lists</u> .....	<u>29</u>
<b>Appendix 2.0</b>	<b>RS-232 connection and setup .....</b>	<b>38</b>
<b>Appendix 3.0</b>	<b>USB connection and setup .....</b>	<b>39</b>

USB Driver Installation .....39

Appendix 4.0 Ethernet setup..... 45

Appendix 5.0 GPIB setup and control..... 47

Setting the GPIB Address.....47

GPIB control.....47

## Section 1.0 Overview

The DOP-201 is a degree-of-polarization (DOP) measurement system that integrates General Photonics' PolaRite™ II/III polarization controller, an optical polarization detection circuit, and a microprocessor based electronic control circuit in a 2U-height, half-rack size enclosure. The DOP-201 uses a proprietary measurement scheme that is independent of optical wavelength, optical source bandwidth, and optical source degree of polarization.

The DOP-201 can simultaneously measure not only DOP value, but also optical signal-to-noise-ratio (OSNR) and noise figure (NF).



**Figure 1 DOP-201 Degree of Polarization Meter**

### 1.1 Principle of Operation

The operational principle of the DOP-201 is based on the definition of degree-of-polarization. A general, partially polarized light beam can be characterized as being composed of two components: a totally polarized component and a totally unpolarized component. The degree of polarization is defined as the ratio of the power of the totally polarized component to the total power of the optical wave:

$$DOP(\%) = \frac{P_p}{P_{up} + P_p} \times 100\% = \frac{P_p}{P_t} \times 100\% \quad (1)$$

where  $P_p$  is the power of the polarized light component,  $P_{up}$  is the power of the unpolarized light component, and  $P_t$  is the total incident light power. The DOP can also be expressed in terms of Stokes parameters.

$$DOP(\%) = \frac{\sqrt{S_1^2 + S_2^2 + S_3^2}}{S_0} \times 100\% \quad (2)$$

DOP ranges from 0% for unpolarized light to 100% for totally polarized light. A partially polarized light beam has a DOP value between 0% and 100%.

There are many methods for measuring the DOP of an optical beam. The DOP-201's approach is deterministic, wavelength insensitive, and accurate. Since the DOP measurement is based on the fundamental physical properties of partially polarized light, without the use of intermediate parameters, it never requires instrument calibration. This makes it an ideal solution for production line DOP measurement, as the instrument operation need never be interrupted for calibration.

Please note that the DOP-201 is not intended for DOP measurement of a polarization-scrambled light source. It is best for CW or quasi-CW optical sources with slow polarization variation.

The relationship between DOP and OSNR is described by the following equation:

$$SNR = \frac{DOP}{1 - DOP} \quad (3)$$

The Noise Figure (NF) of an optical amplifier is defined as the OSNR difference between the input and output of the optical amplifier. In order to measure NF, the OSNR is first measured without the optical amplifier ( $OSNR_1$ ), then the optical amplifier is connected and the new OSNR ( $OSNR_2$ ) is measured. The NF can then be derived from the difference between these two OSNR values:

$$NF = OSNR_1 - OSNR_2 \quad (4)$$

This setup is shown in Figure 2. The amplifier can be any kind of in-line optical amplifier, such as erbium doped fiber amplifiers (EDFA) or Raman amplifiers (discrete or distributed), since the DOP-201 can be used as a real time, in-line meter/monitor.

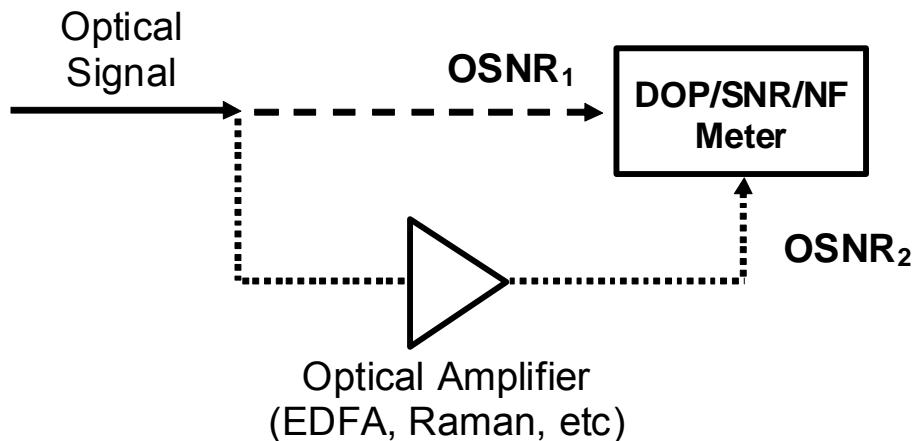

**Figure 2 Measurement of Noise Figure (NF)**

The standard DOP-201 covers a 1440-1620 nm fiber transmission window.



## Section 2.0 Features

### 2.1 Front Panel and Optical Inputs

The front panel of the DOP-201 is shown in Figure 3.



Figure 3 DOP-201 front panel

Front panel features:

OLED display: Displays data and operation mode information

Power: Power on/off switch

Input: Connector adapter for light source input

Thumb Wheel: Scroll through menus and change control parameters

Keypad: Access measurement and setup functions

DOP: DOP measurement

SNR/NF: Toggles between SNR and NF measurement

REF: Set reference for NF measurement

LOCAL: Return to front panel control from remote control

SETUP: Access the Setup menu

◀ ▶: Navigate selections or move cursor position

ENTER: Select menu option or move to setup for next parameter

### **Fiber Connectors**

The DOP-201 has a connector adapter on the front panel for light source input. It is a universal connector interface (UCI), which features a male-type adapter top piece that can be removed for direct access to the ferrule end for routine cleaning and maintenance without removing the entire adapter from the panel. This feature helps avoid high insertion loss, high return loss and measurement instability caused by dirty or contaminated connectors. In addition, the universal interchangeable adapter allows the user to switch to ST, SC, or FC connectors without opening the instrument panel. Although the DOP-201 is typically shipped with an FC fiber adapter, other interchangeable inserts are available. For additional information on different input fiber adapter inserts, please contact General Photonics.

External fiber connectors should be cleaned using industry standard cleaning methods before connection to the DOP-201. If this procedure is followed before each connection, the instrument's internal connector ferrule should not need regular cleaning. However, high insertion loss or measurement instability that does not improve after cleaning the external connectors may indicate that the instrument's internal connector ferrule requires cleaning.

### **Ferrule Cleaning Procedure**

Each connector ferrule is contained in a universal connector interface consisting of a front piece that connects to the external fiber connector, and a base piece that is mounted on the front panel of the instrument, as shown in Figure 4. To clean a connector ferrule, first, make sure no external connector is connected to the universal connector interface. Then, using a Phillips screwdriver, remove the two small screws connecting the front and back parts of the adapter, and carefully pull the front flange straight out. (Note: never remove the adapter base from the front panel). The ferrule end should now be exposed. Clean the ferrule using standard cleaning procedures (compressed air or a fresh lint-free tissue and alcohol or other connector-cleaning solvent), taking care to avoid scratching the ferrule surface. Finally, replace the front flange (position it so that the key notch faces up, and the small alignment pin lines up with the hole in the base piece, before pushing it in) and the screws. For frequent measurements, we recommend that the user prepare a patch cord fiber to avoid wear on the internal connector.

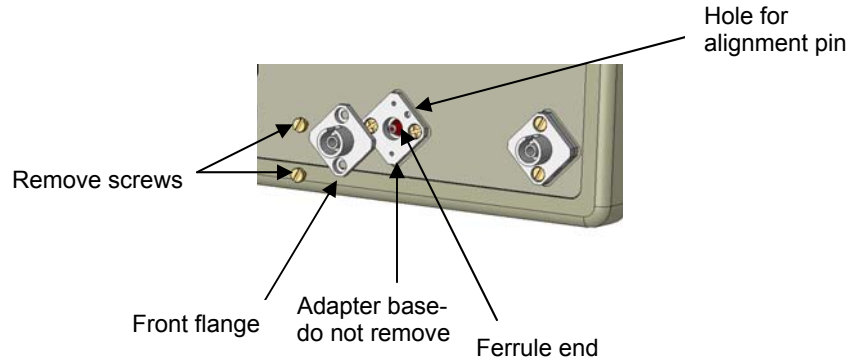
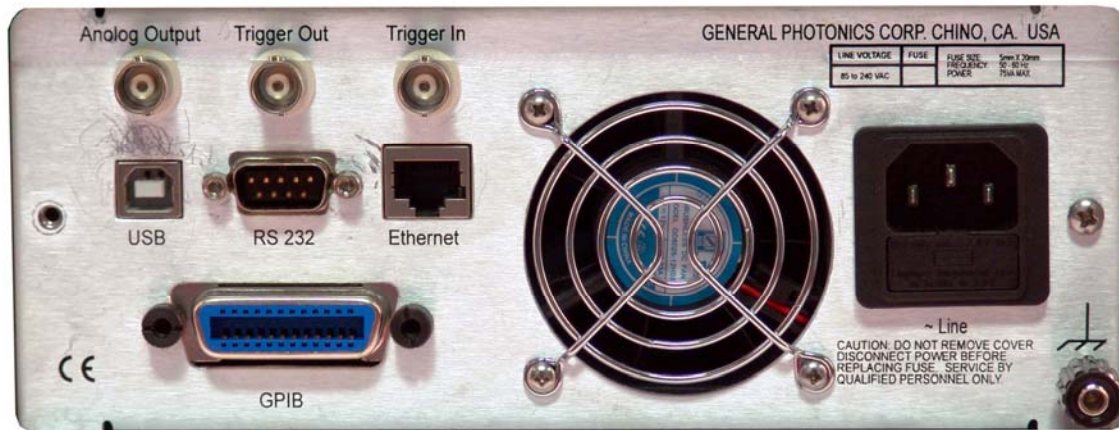

**Figure 4 Diagram of universal connector interface**

## 2.2 Rear Panel: Electrical and Remote Control Interfaces

The AC power plug, fuse, analog output, trigger and communication interface connectors are mounted on the rear panel, as shown in Figure 5.

The DOP-201 includes RS-232, USB, Ethernet, and GPIB interfaces for external computer operation of the system. Control commands and remote interface setup information are located in the appendices.



**Figure 5 rear panel**

Rear Panel Features:

Analog Output: BNC for DOP monitor voltage	Line: External AC input connector
Trigger Out: BNC for output trigger	Cooling fan air outlet
Trigger In: BNC for input trigger	Chassis ground
USB 2.0 interface port	
RS-232 serial interface port	
Ethernet interface port	
GPIB interface port	

### Fuse location:

Figure 6 shows the location of the fuse compartment under the power cord plug. There are two fuses in the compartment- the one in use and a spare. The fuse further inside the compartment is active. The one closer to the compartment opening is the spare.

Replace the fuse with one with the exact rating of the original.



**Figure 6 Fuse compartment**

## Section 3.0                      Operation Instructions

### 3.1 Unpacking

Inspect DOP-201 for any physical damage due to shipping and transportation. Contact carrier if any damage is found. Check the packing list to see if any parts or accessories are missing.

#### Packing List

Item #	Description
1	DOP-201
2	Power cord
3	RS-232 cable (straight-wired)
4	USB cable
6	User guide
7	Software cd

### 3.2 Front Panel Operation

1. Connect power cord and plug it into wall receptacle. Make sure the ground pin of the power cord is connected to earth ground.
2. Connect DUT (light source or amplifier). Make sure light source is turned off while cleaning connectors and making connections.
3. Power on the light source. Make sure that the input power is within range.

It is important to use a zero or low polarization dependent loss (PDL) attenuator when input optical power exceeds the specified power limit (+6 dBm). The PDL of the components preceding the input connector can affect the DOP measurement accuracy, particularly at low DOP values. For example, a PDL of 0.1 dB will increase measurement uncertainty by  $\delta = (10^{PDL/10} - 1) \times 100\% = (10^{0.01} - 1) \times 100\% = 2.3\%$

4. Turn on the instrument. It will run through an initialization sequence and then run a brief self-test before proceeding to the default measurement screen. If the optical power is out of range, it will display a "power low" or "power high" message.



## 3.3 Operation Modes

The DOP-201 has three main measurement modes.

### DOP/Power measurement

In DOP/Power mode, the DOP-201 measures the DOP and power of the input light.

This is the default measurement mode. After the DOP-201 completes its self-test on power-up, it goes into DOP/Power measurement mode. This mode can also be accessed by pressing the DOP button on the front panel.

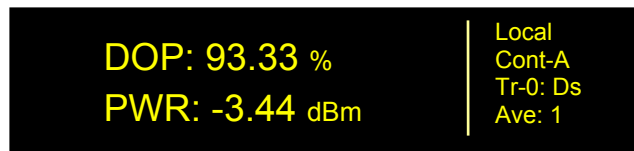

The left side of the screen displays measured parameters:

DOP: Measured DOP, in %

PWR: Measured power, in selected units (dBm or mW)

The right side of the screen displays several operation status and parameter settings:

Control Mode: Local (front panel) or Remote

Measurement timing mode:

Continuous measurement (Cont): Instrument continuously measures DOP and power, and data are updated in real time. If analog output is enabled, the display will read "Cont-A", as in the example above.

Single measurement (Sing): Instrument takes and displays one measurement. If analog output is enabled, the display will read "Sing-A". The DOP-201 can only be switched to single measurement mode under remote control. Pressing the Local button when the instrument is in single measurement mode will switch it back to continuous measurement.

Triggered measurement (Tr-I): If the input trigger is enabled, this line will show the input trigger edge selection, e.g. "Tr-I: Ri" or "Tr-I: Fa".

Output trigger status (Tr-O): To help with synchronization with other instruments, the DOP meter can output a trigger pulse at the completion of each measurement. This line shows the output trigger status: Disabled (Ds), rising pulse (Ri), or falling pulse (Fa).

Ave: Number of measurements to be averaged per displayed value (applies to DOP, SNR, NF and Power measurements).

The wavelength, averaging, power unit, trigger, and analog output settings can be accessed from the Setup menu.

If the instrument is in remote control, the LOCAL button restores front panel control.

### Signal to Noise Ratio (SNR) Measurement

Press the SNR/NF button once to access SNR measurement.

This is an uncalibrated measurement that does not use a filter to take the noise bandwidth into account, so the resulting SNR value is generally smaller than it would be if normalized with a 0.1 nm bandwidth filter. It is useful for relative measurement, but a calibrated measurement should be used for absolute measurements.

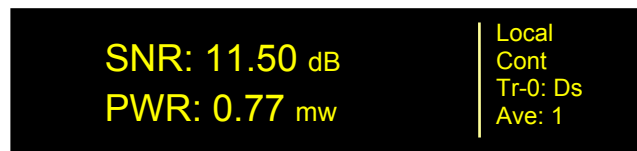

Measured parameters:

SNR: Measured SNR, in dB

PWR: Measured power, in selected units (dBm or mW)

The operation status area at the right of the screen is the same as for DOP measurement.

### Noise Figure (NF) Measurement

From SNR measurement, press the SNR/NF button again to access NF measurement.

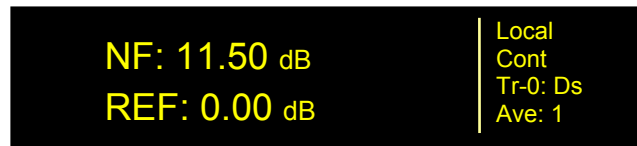

Measured parameters:

NF: Measured NF, in dB

REF: Reference OSNR used for NF measurement, in dB

The operation status area at the right of the screen is the same as for DOP measurement.

The NF of an amplifier is defined as

$$NF = OSNR_1 - OSNR_2$$

where  $OSNR_1$  is the OSNR measured without the amplifier under test in the optical path, and  $OSNR_2$  is the OSNR measured with the amplifier under test added to the optical path.

The NF value displayed on the screen is

$$NF = \text{current measured SNR} - \text{reference SNR}$$



If no reference has been taken by the user, the instrument uses 0.00 dB as the default reference value, as shown in the example above.

The user can update the reference SNR by pressing the REF button on the front panel. The current measured SNR will be recorded as the reference for NF measurement and displayed in the REF line. During reference updating, the screen will display "Reading Reference" as well as the power level in dBm and mW.

## Setup

The setup menu allows the user to set up several operation parameters.

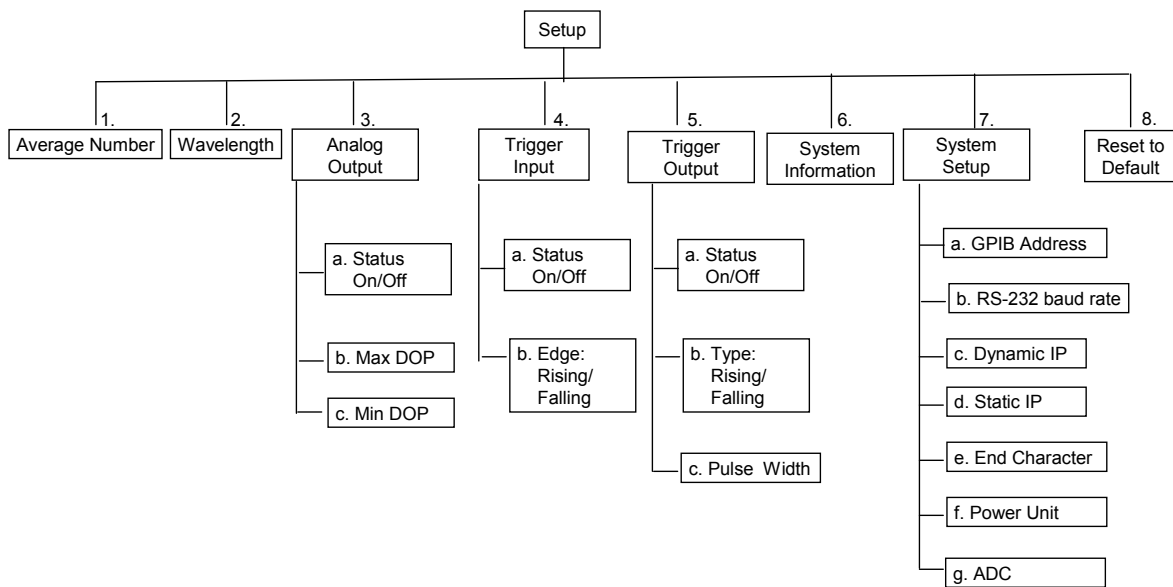

**Figure 7 Setup menu hierarchy**

Press the SETUP button on the front panel to bring up the Setup menu. The screen displays 2 options at a time:

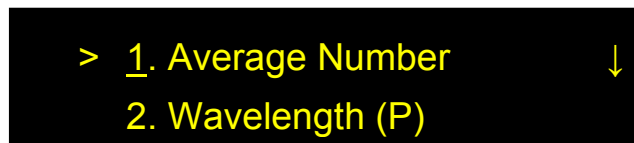

Etc.

Use the wheel to scroll through options and the ENTER key to select an option.

Most setup parameters are written to nonvolatile memory and retained after power-off. Exceptions are noted in the descriptions below.

### Average Number:

The measured values (DOP, SNR, NF, Power) are averaged over the selected number of max/min search cycles.

Average Number

1

Use the arrow keys to move the cursor, the wheel to change the value of the selected digit, and ENTER to execute the setting and return to the SETUP menu.

Range: 1 to 256

Default value: 1

### Wavelength:

The wavelength setting is used for power measurement calibrations. Matching the DOP-201's wavelength setting to the wavelength of the light source ensures the accuracy of the power measurement. The wavelength setting does not affect the accuracy of the DOP, SNR, or NF measurements.

Wavelength(P)

1550 nm

Use the arrow keys to move the cursor, the wheel to change the value of the selected digit, and ENTER to execute the setting and return to the SETUP menu.

Calibrated Wavelength Range: 1440-1620nm

Default Value 1550nm

### Analog Output:

The DOP meter has a 0-5V analog monitor voltage that can be used to monitor the DOP of the light source under test. The voltage varies linearly with DOP, and the user can select the DOP limits corresponding to the maximum and minimum monitor voltage. The default settings are  $DOP_{Max} = 100\%$  and  $DOP_{Min} = 0\%$ , so  $V_{out} = 5V$  corresponds to  $DOP = 100\%$ , and the 5V voltage range covers a DOP range of 100%. However, if the DOP is expected to be between 10 and 40%, for example, the user can set  $DOP_{Max}$  to 40% and  $DOP_{Min}$  to 10%. In this case,  $V_{out} = 5V$  corresponds to  $DOP = 40\%$ , and the 5V voltage range covers a DOP range of 30%. This allows for better accuracy if the DOP range being monitored is small.

Output connector: BNC connector on rear panel

Monitor Voltage Range: 0-5V

To use the monitor voltage,

1. Connect the analog voltage BNC connector to the monitoring circuit.

2. Set the analog voltage operation parameters.

There are 3 setup parameters:

3a: Analog Out: ON	Options: ON, OFF	Default: ON
3b: DOP <sub>Max</sub> : 100.00	Range: 00.01 to 100.00%	Default: 100%
3c: DOP <sub>Min</sub> : 0.00	Range: 00.00 to (DOP <sub>Max</sub> – 0.01)	Default: 0%

With the cursor on the index number, use the wheel to scroll between options. Use the ENTER key to move the cursor from index selection to parameter setting. With the cursor on the parameter to be set, use the arrow keys to move the cursor position and the wheel to change the value of the selected digit or parameter. When the parameter is set, use the ENTER key to move the cursor back to the index position.

The Min and Max DOP settings are retained after power-off, but the analog output enable/disable setting is not. On power-up, the analog output will be enabled.

### Trigger Input:

With the input trigger enabled, the DOP meter takes one measurement when it receives a trigger pulse. This function can be used for synchronization with other equipment.

The user can select whether to trigger on the rising or falling edge of the input pulse.

**4a: Trigger-In: OFF**  
**4b: Trigger: Rising**

With the cursor on the index number, use the wheel to scroll between options. Use the ENTER key to move the cursor from index selection to parameter setting. With the cursor on the parameter to be set, use the arrow keys to move the cursor position and the wheel to change the value of the selected digit or parameter. Use the ENTER key to execute the setting and move the cursor back to the index position.

Input trigger settings are not retained after power-off. On power-up, the input trigger will be set for rising edge, and the trigger will be disabled.

The amount of time needed per measurement depends on the average number setting, which determines the number of max/min search cycles required to complete one measurement.

Input trigger connector: BNC connector on rear panel



Pulse voltage: TTL levels

Minimum pulse width: 2 ms

Minimum interval between pulses: 30 ms × average number setting

## Trigger Output:

With the output trigger enabled, the DOP meter generates a trigger pulse each time it completes a measurement. This function can be used for synchronization with other equipment.

The user can set the width of the pulse and whether it is a rising  or falling  pulse.

There are 3 setup parameters:

5a: Trigger Out: OFF	Options: ON, OFF	Default: OFF
5b: Trigger: Rising	Options: Rising, Falling	Default: Rising
5c: Pulse-Wt: ____25us	Range: 1 to 65535 $\mu$ s,	Default: 25 $\mu$ s

With the cursor on the index number, use the wheel to scroll between options. Use the ENTER key to move the cursor from index selection to parameter setting. With the cursor on the parameter to be set, use the arrow keys to move the cursor position and the wheel to change the value of the selected digit or parameter. Use the ENTER key to execute the setting and move the cursor back to the index position.

Only the pulse width setting is retained after power-off. On power-up, the output trigger will be set for a rising pulse, and the trigger will be disabled.

Output trigger connector: BNC connector on rear panel

Pulse voltage: TTL levels

## System Info.

This option displays the instrument's model number and firmware version.

Mod: DOP-201-V1.1  
Sw: V1.1-140805A

## System Setup:

This section contains the setup options for remote control and unit selection for the power display.

### a. GPIB Address

GPIB Address  
05

This option sets the instrument's GPIB address.

Range: 1-30

Default: 5

Use the wheel to change the GPIB address and press ENTER to execute the new setting.

**b. RS-232 Baud rate**

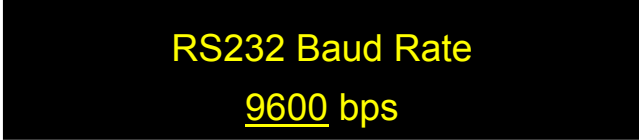

RS232 Baud Rate  
9600 bps

Use the wheel to change the RS-232 baud rate setting, and ENTER to execute the new setting.

Options: 110, 300, 600, 1200, 2400, 4800, 9600, 19200, 28800, 38400, 43000, 56000, 57600, 115200, 128000, 230400, 460800

Default: 9600

**c. Dynamic IP**

The instrument's IP address must be known in order to control it via Ethernet.

The "Dynamic IP" option sets the instrument for dynamic IP addressing and requests a dynamic IP address from the server.

From the System Setup menu, select "Dynamic IP", then press the ENTER key to request a dynamic IP address from the server.

If the instrument is able to establish communication with the DHCP server and successfully retrieve an IP address, the address will be displayed on-screen.

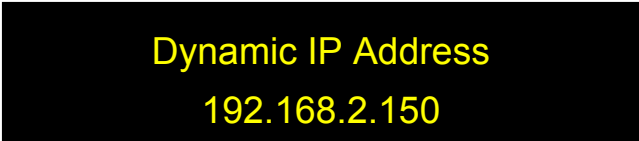

Dynamic IP Address  
192.168.2.150

If the instrument is unable to connect to the server, it may display 0.0.0.0. In this case, first, check the connection, and if necessary, re-send the request.

Dynamic IP addressing is the default Ethernet communication mode for this instrument. After power-off, it will revert to dynamic IP addressing when it is powered back on.

Each time this menu option is selected, the instrument requests a dynamic IP address from the server. If this menu option is selected while the instrument is already in communication using a dynamic IP address, the instrument may be assigned a dynamic IP address other than the one it is currently using. This may interrupt communication, and the address may not be displayed correctly on the front panel.

### d. Static IP

Selecting “Static IP” allows the user to set the instrument for Ethernet communication using static IP addressing and to set the static IP address, Net Mask, Gateway, Name Server, and Port. The setup screens for this option are as follows:

IP Address ↓  
a. 192.168.002.106

Netmask ↑ ↓  
b. 255.255.255.000

Gateway ↑ ↓  
c. 192.168.002.001

Nameserver ↑ ↓  
d. 192.168.002.001

Port ↑ ↓  
e. 023

Update Parameters ↑  
f. No Yes

With the cursor on the index number (a-f), use the wheel to move between static IP setup parameter options.

Press the ► key to move to setup for the displayed parameter.

Use the arrow keys (◀▶) to move the cursor position and the wheel to change the value of the active digit. Once the parameter is set, press ENTER to move the cursor position back to the parameter index (a-f).

When all of the parameters are set, select “Yes” on the “Update Parameters” screen (index f) and press ENTER to apply the settings and set the instrument to static IP addressing.

The display will briefly show:

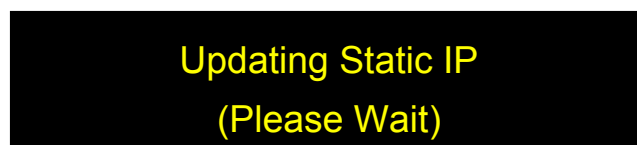

and then return to the Setup menu.

The default port setting is 23. In most cases, this does not need to be changed.

If the instrument was originally in dynamic IP mode, it does not change to static IP mode until the user selects "yes" on the "Update Parameters" screen, regardless of whether any of the static IP addressing parameters were actually changed.

### e. Ending Char

This option selects the remote control command format. It allows the user to select SCPI or GP command formats, and to specify the end-of-string (EOS) indicator for SCPI.

**Terminating Character**  
**SCPI: <CR + LF>**

Options:	SCPI:<CR + LF>	SCPI format, EOS = carriage return and line feed
	GP	GP legacy command format
	SCPI:<CR>	SCPI format, EOS = carriage return
	SCPI:<LF>	SCPI format, EOS = line feed
Default:	SCPI: <CR + LF>	

Rotate the wheel to change the end-of-string indicator setting. Press ENTER to execute the new setting and return to the main menu.

Make sure the command format and EOS settings match the format of the remote control commands being used. Otherwise, the instrument will not recognize the commands.

### f. Power Unit

The measured power can be expressed in terms of dBm or Watts. The default setting is dBm.

**Power Unit**  
**dBm**

Rotate the wheel to toggle between dBm and Watts. Press ENTER to execute the setting and return to the SETUP menu.

### g. ADC Averaging

This setting allows the user to select the number of ADC samples averaged to generate a measurement. This is different from the "average number" setting, which selects the number of measurement cycles used to generate the displayed measurement result.

## ADC Averaging

## 16

Rotate the wheel to cycle through options. Press ENTER to execute the setting and return to the SETUP menu.

Options: 1, 2, 4, 8, 16, 32, 64, 128, 256

Default: 16

**Reset to Default**

Select this option from the Setup menu and confirm update to restore all operation parameters to their initial factory settings, listed below. Use the arrow keys, not the wheel, to move between "no" and "yes".

Display Mode	DOP/Power
Run Mode	Continuous Measurement
Analog Output	ON
DOP Range for analog output	min = 0%, max = 100%
Trigger In	Disabled
Trigger Out	Disabled
Trigger Output Pulse Width	25 $\mu$ s
Control	Local
Wavelength	1550 nm
Averaging	1
Ending Character	SCPI <CR+LF>
Communication Indicator	OFF
GPIB Address	5
DOP Unit	%
Power Unit	dBm
RS-232 Baud Rate	9600 bps
ADC Averaging	16 Samples
Ethernet communication	Dynamic IP



## 3.4 Troubleshooting

The performance of the DOP-201 can be tested using light sources of known DOP.

### General Guidelines

1. For accurate measurement, the output power of the light source under test must be stable over the measurement period.
2. Components with PDL in the optical path can affect the accuracy of the measurement.
3. To ensure a stable measurement result, place the setup on a stable surface and fix SM fibers in place.

### Remote Control

#### **Command Format**

1. Make sure the "Command Type" setting (SCPI or GP) matches the format of the actual command format to be used.
2. SCPI format: Command strings without an end-of-string (EOS) character will not be executed. Make sure that the "Terminating Character" setting matches the EOS being used.
3. GP format: If the beginning ("\*") or ending identifiers ("#" or "?") of a command are missing, the instrument will not respond.

#### **RS-232**

1. Make sure that the cable is straight-wired (pin-to-to pin wired) not cross-wired.
2. Verify active Comm Port (COM1, COM2, etc.).
3. Verify Comm Port settings: 8 data bits, 1 stop bit, no parity bits.
4. Make sure baud rate setting on instrument matches baud rate being used by control computer.

#### **USB**

1. Make sure that the USB driver is installed before communicating via USB.

#### **Ethernet**

1. Make sure that the Ethernet communication setting (Static or Dynamic) matches the Ethernet addressing type being used.
2. Make sure that the cable type is correct: cross-linked cable for static IP with direct instrument-to-computer connection, straight-linked cable for connection through a switch or router (for either static or dynamic IP).
3. Every time "Dynamic IP" is selected from the Setup menu, the instrument requests a new dynamic IP address from the server. If this happens while the instrument is already in communication via dynamic IP, the communication may be interrupted.



## Section 4.0

## Specifications

### Optical

Operating Wavelength Range	1440-1620 nm
DOP Resolution	0.01%
DOP Accuracy <sup>1</sup>	±0.5% (single sample) ±0.2% (10 sample average)
Repeatability	± 0.2% (10 sample average)
DOP Range	0 to 100%
Measurement Speed	30 ms/measurement for input power > -30 dBm
Operating Power Range	-40 to +6 dBm
Optical Power Accuracy	±0.25 dB
Wavelength Calibration for power measurement	1440-1620nm

Note:

1. At 23±5°C.

### Electrical/Communication

Front panel display	OLED graphic display
Power Supply	100-240VAC, 50-60 Hz
Analog Output	0 to 5V DOP monitor voltage User-configurable DOP range
Input/Output Triggers	TTL pulse, BNC connector
Communication Interfaces	RS-232, USB, Ethernet, GPIB
GPIB Address	1-30
RS-232 Baud Rate	110, 300, 600, 1200, 2400, 4800, 9600, 19200, 28800, 38400, 43000, 56000, 57600, 115200, 128000, 230400, 460800

### Physical and Environmental

Dimensions	Standard 2U half-19" rack mount size <sup>1</sup> 14" (L) × 8.5" (W) × 3.5" (H)
Optical Connectors	FC/PC, FC/APC
Weight	7.5 lb
Operation temperature	0 to 50°C
Storage Temperature	-20 to 70°C

1. Rack mount kit available. Contact General Photonics for details.



## Appendices

The following appendices include the remote control command lists, as well as setup information for different control interfaces.

### Appendix 1.0 Remote Control Commands

The commands and responses listed in Table 1, Table 2, and Table 4 are the same for all communication protocols: RS-232, USB, Ethernet, and GPIB.

When the DOP-201 is in remote control, the front panel keypad is locked. Press the LOCAL key to return to front panel control. The top right section of the front panel display indicates whether the instrument is in remote or front-panel control.

The DOP-201 needs to be set to respond to a particular command format before it can receive commands. Use the "Terminating Character" setup screen under "System Setup" to select the command format (SCPI or GP), and for SCPI, the end of string (EOS) character, before sending commands.

For SCPI commands, multiple commands can be concatenated in one string, using semicolons as separators, up to a limit of 128 characters per string.

For GP format commands, only one command string can be sent at a time.

Results for data queries are average measurements. The number of max/min search cycles to be averaged for one result can be set from the front panel setup menu or using the corresponding remote control command. In continuous measurement mode, if a data query command is sent, the returned value is the average of the most recent set of x measurement cycles, where x is the average number setting. In single measurement mode, each time a data query command is sent, the instrument will perform the requisite number of max/min search cycles and return the average value. In triggered measurement mode, when a trigger pulse is received, the instrument will perform the requisite number of max/min search cycles and calculate the average value. This is the result that will be returned if a query command is sent before the next trigger pulse is received.

### Command Lists

#### SCPI Commands

SCPI command notes:

1. Each command sequence can be queried by using "?" in place of set parameters to check the command's current parameter settings. There is no space between the command sequence and "?".
2. There is a space between a command sequence and a set parameter. Settable parameters are listed in the table using triangular brackets < >.

3. Command segments listed in the table in square brackets [ ] are optional; they are included for human interpretability.
4. Many command segments can be written out as full words or in pre-defined abbreviated forms consisting of 3 or 4 letters. The abbreviated commands are capitalized in the command sequences listed in the table. E.g. the firmware version query command can be written out as either :SYSTem:VERSion? or :SYST:VERS?
5. Multiple command strings can be concatenated using a semicolon “;”.
6. An end-of-string (EOS) is required to execute a complete command string, the EOS can be configured as Line Feed (LF), Carriage Return (CR), or both (CR + LF). The default EOS is CR + LF (0D 0A in HEX)

**Table 1 SCPI Remote Control Command List**

Command Sequence	Set Parameters	Description/Example
<i>System/Communications Setup</i>		
:SYSTem:ERRor?		Returns earliest error code in memory and clears location after readout. 20 error messages max. Errors read out in FIFO sequence.
:SYSTem:ERRor:COUnT?		Returns number of errors. This allows the control program to quickly determine if an error exists rather than querying the device after each command.
:SYSTem:VERSion?		Query Firmware Version Return Sample: DOP-201,V1.1,140805A
:SYSTem:GPIB:ADDResS?		Query GPIB address. Set from front panel. Value stored to memory. Range: 1 to 30. Factory default: 5

<i>System Status</i>		
:STATus:MODE?		Query current system mode: Possible Responses: DOP: DOP and Power Display Mode; SNR: SNR and Power Display Mode; NF: NF and Reference Display Mode; RREF: NF Reference Update Mode SSET: System Setup Mode.
:STATus:QUESTionable:EVENT?		The query returns the value of the Questionable Event Register. Reading the register clears all bits. Query only.
:STATus:QUESTionable:CONDition?		The query returns the value of the Questionable Condition register.
:STATus:QUESTionable:ENABle	<integer>	Set corresponding bit in Questionable Event Enable register to 1. Range: 0 ~ 32767 Or query corresponding bit in Questionable Event Enable register.
:STATus:OPERation:EVENT?		The query returns the value of the Operation Event Register. Reading the register clears all bits.
:STATus:OPERation:CONDition?		The query returns the value of the Operation Condition register.
:STATus:OPERation:ENABle	<integer>	Sets corresponding bit in Operation Event Enable register to 1. Range: 0 ~ 32767 Or query corresponding bit in operation event enable register.

## DOP-201 User Guide



<i>Data and Settings</i>		
:SENSe:WAVelength	<integer>	Set/query the operation wavelength, in units of nm. Wavelength range: 1440 to 1620 nm. Setting stored to nonvolatile memory. Factory reset value is 1550nm
:SENSe:AVERage	<integer>	Set/query the number of measurement cycles averaged to obtain each DOP, SNR, NFV, or power value. Range: 1 to 256. Default: 1.
:SENSe:ADConverter:ADAVerage	<integer>	Set/query the Analog to Digital Converter sample averaging. Options: 1, 2, 4, 8, 16, 32, 64, 128 or 256. Default: 16
:SENSe:DOP?		Query DOP. Returned value will be in % or decimal form, depending on selected units.
:SENSe:DOP:UNIT?		Query DOP Unit setting. Response: "PER" (=%) or "DEC" (=decimal) Note: DOP unit setting affects only query responses. Front panel display is always in %.
:SENSe:DOP:UNIT 1		Set DOP units to Decimal. (Returned value will always be between 0.0000 and 1.0000 (4 decimal places))
:SENSe:DOP:UNIT %		Set DOP units to Percent. (Returned value will always be between 0.00 and 100.00 (2 decimal places))
:SENSe:NFIGure?		Query the, Noise Figure. Returned value is in dB.
:SENSe:SNR?		Query the SNR (Signal to Noise Ratio). Returned value is in dB.
:SENSe:REF?		Query reference SNR value used for NF measurement. Units: dB.
:SENSe:REFerence:UPDate		Update reference SNR value for NF measurement. Takes an SNR measurement and stores it to memory. Units: dB.
:SENSe:POW?		Query Power. Units for returned value depend on unit setting. Note: if units are set to Watts, results are returned in mW.
:SENSe:POWer:UNIT	<DBM WATT>	Set/query power units for front panel display and data query response. Options: dBm or Watts Default: dBm

<i>Sampling Mode</i>		
:SENSe:MODE?		Query the data sampling type. CONT: Continuous measurement mode, SING: Single measurement mode, TFAL: Triggered measurement, falling edge TRIS: Triggered measurement, rising edge
:SENSe:MODE	<string>	Set the data sampling type. CONT: Continuous measurement mode SING: Single measurement mode TRIG: Triggered measurement  Note: When in single mode, the data is updated when a data query is received. This mode can only be accessed using this command (no front panel access). If the instrument is in single measurement mode, pressing the LOCAL key will return it to continuous mode.

## DOP-201 User Guide

<i>Analog Output (DOP monitor voltage)</i>		
:OUTPut:STATe	<ON OFF>	Set/query analog output enable/disable status. ON: Enabled OFF: Disabled  When in Continuous Mode the display will indicate Analog Enabled with "Cont-A", and when in Single Sampling Mode the display will indicate Analog Enabled with "Sing-A"
:OUTPut:RANGe:DOP	<float1>,<float2>	Set/query the DOP range corresponding to the 0-5V analog monitor voltage. <float1> = <i>minimum</i> DOP <float2> = <i>maximum</i> DOP DOP range for <float1> and <float2> is 0.00 to 100.00 %, and <float1> must be less than <float2>.  Query response format: <float1>,<float2>

<i>Input Trigger</i>		
:TRIGger:INPut:STATe	<ON OFF>	Set/query input trigger enable/disable status ON: Enabled. Instrument takes one measurement per trigger edge received. OFF: Disabled Default: Disabled
:TRIGger:INPut:TYPE	<REDG FEDG>	Set/query trigger edge type; REDG: rising edge FEDG: falling edge Default: Rising edge

<i>Output Trigger</i>		
:TRIGger:OUTPut:STATe	<ON OFF>	Set/query output trigger enable/disable status ON: output trigger enabled, OFF: output trigger disabled Default: Disabled
:TRIGger:OUTPut:TYPE	<REDG FEDG>	Set/query output trigger pulse type  REDG: rising pulse  FEDG: falling pulse  Default: Rising pulse
:TRIGger:OUTPut:PWIDth	<integer>	Set/query output trigger pulse width. Range: 1-65535 µs Default = 25 µs.

**Table 2 SCPI Common Commands and Queries (GPIB specific)**

These commands are common to all GPIB-enabled devices.

Command	Description
*CLS	Clear Status Command
*ESE <NR1>	Standard Event Status Register Enable. Range: 0..255 Power-up default is last setting (stored to memory).
*ESE?	Standard Event Status Enable Query. Power-up default is last setting (stored to memory).
*ESR?	Standard Event Status Register Query
*IDN?	Identification Query. Response: GP,DOP-201,V1.1-140805A-SN:15100000xxxx
*OPC	Operation Complete Command
*OPC?	Operation Complete Query. Returns a 1 if No Operation Pending flag is TRUE.
*RST	Reset Command
*SRE <NR1>	Service Request Enable Command. Range: 0..255 Power-up default is last setting (stored to memory).



*SRE?	Service Request Enable Query.
*STB?	Read Status Byte Query. Reads Instrument Summary Status Register.
*TST?	Self-Test Query. 0 if Pass.
*WAI	Wait-to-Continue Command. This instrument executes all commands in order so there are never any pending operations (this command has no effect).

**Table 3 SCPI Error and Status Codes**

Error code	Description
0	"No error"
-100	"Command error"
-101	"Invalid character"
-108	"Parameter not allowed"
-109	"Missing parameter"
-110	"Command Header Error"
-111	"Header Separator Error"
-112	"Program mnemonic too long"
-113	"Undefined header"
-114	"Header suffix out of range"
-115	"Unexpected number of parameters"
-120	"Numeric data error"
-121	"Invalid character in number"
-222,	"Data out of range"
-300	"Device-specific error"
-350	"Queue overflow"
-420	"Query Unterminated"

### GP Format Commands

General Photonics also provides a command list using the GP legacy format to make it easier for DOP-101 users to modify existing programs for use with a DOP-201.

Notes for DOP-101 users:

- 1) Make sure that the DOP-201 is set to receive GP format commands (Setup →System Setup→Ending Char→GP from front panel). Otherwise, it won't recognize GP format commands. The DOP-201's default command setting is SCPI with <CR + LF> as EOS.
- 2) Indicators: The DOP-101 had indicators enabled by default. For example, it would respond to a DOP query with \*DOP 98.87#. The DOP-201 has indicators disabled by default. If your program expects indicators in the response, use the \*IND ENA# command to turn on the indicators. Note that the indicator enable/disable status is not saved after power-off.
- 3) Units: The DOP-101 returned DOP in % and power in dBm. The DOP-201 gives the user a choice of % or decimal format for DOP and dBm or Watts for power. When modifying a DOP-101 program, it may be necessary to add unit setup commands to make sure that the DOP-201 returns data using the expected units.
- 4) GPIB address setup: The DOP-101 had a command for GPIB address setup. The DOP-201 requires that the GPIB address be set from the front panel.
- 5) Ethernet setup: On the DOP-201, Ethernet setup should be done from the front panel. There are no commands in the GP format for Ethernet setup.

## DOP-201 User Guide

- 6) Begin/end continuous DOP measurement: The commands to set up continuous DOP measurement are different in the DOP-101 and DOP-201.

DOP-101	DOP-201	Function description
*BGN#	*MOD CON#	Begin continuous measurement
*END#	N/A	Stop measurement

**Table 4 GP Format Commands**

System Information		
Command	Description	Sample response with indicators disabled
*IND?	Query parameter indicator enable/disable status. ENA = enabled DIS = disabled Indicator status resets to disabled at power-up.	*DIS# (indicators off)
*IND ENA#	Enable parameter indicators. With indicators enabled, responses to query commands will include parameter labels before the values. Indicators do not affect the front panel display. Indicator status resets to disabled at power-up.	Example: Wavelength query response with Indicator enabled: *WAV 1550# Indicator disabled: *1550#
*IND DIS#	Disable parameter indicators. (Default state on instrument power-up)	Example: Response to wavelength query with indicator disabled is *1550#
*IDN?	Query product identification Information.	*IDN GP DOP-201 V1.1 SN:151000000242# or *Enn# if error
*VER?	Query the firmware version	*V1.1,140805A# (Response is Version Dependent )
*ADR?	Query the current GPIB address. Value stored in non-volatile memory. Range 1 – 30. Default: 5 (GPIB address can be set from front panel)	*5#
*WAV?	Query operating wavelength used for power measurement.	*1550#
*WAV wav#	Set operating wavelength. Range: 1440-1620nm Default: 1550nm Setting written to nonvolatile memory	*E00# Else *Enn# (see error response list)
*AVE?	Query the number of measurement cycles averaged for each measurement. Range: 1 to 256	*5#
*AVE ave#	Set the cycle average number for each measured result. Setting saved to nonvolatile memory. Range: 1 to 256. Factory reset value 1	*E00# Else *Enn# (see error response list).
*RST#	Reset control parameters to factory default values.	*E00# Else *Enn# (see error response list).

## DOP-201 User Guide



Measurement Setup/Queries		
Command	Description	Response/Example
*DOP?	Query DOP. Response will be given in % or decimal form depending on unit setting. Notes: 1. DOP units can only be set via remote control. There is no front panel access. 2. DOP unit setting affects only query response format. Front panel display is always in %.	Response format: *DOP 99.9# for % or *DOP 0.9990# for decimal. Else Enn# (see error response list)
*DOP:UNI?	Query DOP unit setting	Response: *UNI DEC# for decimal or *UNI PER# for percentage
*DOP:UNI DEC#	Set DOP units to decimal. Returned value will always be between 0.0000 and 1.0000 (4 decimal places)	*E00# if no error Else *Enn# (see error response table)
*DOP:UNI PER#	Set DOP units to percentage. Returned value will always be between 0.00 and 100.00 (2 decimal places)	*E00# if no error Else *Enn# (see error response table)
*NFV?	Query the NFV (Noise Figure Value)	Returns the NF Value in dB. Ex: *NFV 2.21#
*SNR?	Query the SNR (Signal to Noise Ratio) Value	Returns the SNR in dB. Ex: *SNR 2.53#
*REF?	Queries SNR reference value used for NF measurement. Units in dB.	Response: *REF -27.56#
*REF#	Update reference value. Saves current SNR as reference for NF measurement.	Response *E00#
*POW?	Queries measured optical power. Response given in W or dBm depending on unit setting. Notes: 1. If unit is set to Watts the measured value is given in mW. 2. Power unit setting affects both query response and front panel display.	Ex: * -30# (dB) or *0.0010# (mW). else *Enn# (see error response table)
*POW:UNI?	Queries power unit setting.	Ex: *UNI dBm# or *UNI WAT#
*POW:UNI WAT#	Set power unit for display and query responses to Watts.	Query response will be in mW, but front panel display will show units as mW or $\mu$ W depending on power level.
*POW:UNI DBM#	Set power unit for display and query responses to dBm.	Query response and display will both use dBm.

Data Sampling Mode Commands		
Command	Description	Response/Example
*MOD?	Query data sampling mode. Responses: *MOD CON# Continuous Measurement *MOD SIN# Single Measurement *MOD TRI# Triggered Measurement	
*MOD CON#	Set sampling mode to continuous measurement (default mode)	Response: *E00# Else *Enn# (see error response list)
*MOD SIN#	Set sampling mode to single measurement. Note: When in single mode the data is updated when a data query is received. This mode can only be accessed using this command (no front panel access). If the instrument is in single measurement mode, pressing the LOCAL key will return it to continuous mode.	Response: *E00# Else *Enn# (see error response list)
*MOD TRI#	Set sampling mode to triggered mode	Response: *E00# Else *Enn# (see error response list)

## DOP-201 User Guide

<b>Analog Output Control</b> Commands related to analog output monitor voltages		
Command	Description	Response/Example
*ANA:STA?	Query analog output monitor voltage enable/disable status.	Response: *ANA ENA# = enabled *ANA DIS# = disabled
*ANA ENA#	Enable analog output	*E00# Else *Enn# see error response list)
*ANA DIS#	Disable analog output	*E00# Else *Enn# see error response list)
*ANA <i>max,min#</i>	Set the DOP range corresponding to the 0-5V analog monitor voltage. DOP range for min and max is 0.00 to 100.00%, and <i>Min&lt;Max</i> .	*E00# Else *Enn# see error response list)
*ANA:RAN?	Query the analog voltage DOP range settings. i.e. <i>maximum and minimum</i> values.	Response * <i>max,min#</i> . Else *Enn# (see error response list)

<b>Input Trigger</b> Trigger signal for externally triggered measurement		
Command	Description	Response/Example
*TRI:INP:STA?	Query the input trigger enable/disable status.	*INP ENA# if enabled and *INP DIS# if disabled else see error response list
*TRI:INP ENA#	Enable input trigger Instrument takes one measurement per trigger edge received.	Response: *E00# Else *Enn# (see error response list)
*TRI:INP DIS#	Disable input trigger Instrument returns to continuous sampling mode (default)	Response: *E00# Else *Enn# (see error response list)
*TRI:INP:EDG?	Query trigger edge type. Options: rising or falling edge.	Response: *EDG RIS# for rising edge *EDG FAL# for falling edge
*TRI:INP RIS#	Set input trigger type to rising edge. Display indicator: TrI Ri when enabled	*E00# Else *Enn# see error response list)
*TRI:INP FAL#	Set input trigger type to falling edge. Display indicator: TrI Fa when enabled	*E00# Else *Enn# see error response list)

<b>Output Trigger</b> Trigger pulse to indicate measurement completed		
Command	Description	Response/Example
*TRI:OUT:STA?	Query output trigger enable/disable status.	Response: *OUT ENA# or *OUT DIS#
*TRI:OUT ENA#	Enable output trigger	*E00# Else *Enn# (see error response list)
*TRI:OUT DIS#	Disable output trigger	*E00# Else *Enn# (see error response list)
*TRI:OUT RIS#	Set output trigger type for rising pulse.  Display indicator: TrO:Ri when enabled.	*E00# Else *Enn# (see error response list)
*TRI:OUT FAL#	Set output trigger type for falling pulse.  Display indicator: TrO:Fa when enabled.	*E00# Else *Enn# (see error response list)
*TRI:OUT:EDG?	Query output trigger pulse type (rising or falling).	Response: *EDG RIS# for rising pulse *EDG FAL# for falling pulse
*TRI:OUT:WID?	Query the trigger output pulse width. Response in $\mu$ s.	Response: *1000# if setting is 1 ms.
*TRI:OUT:WID <i>w#</i>	Set trigger output pulse width. Setting stored to memory. Pulse Width range: 1-65535 $\mu$ s Factory reset value: 25 $\mu$ s	*E00# Else *Enn# see error response list)

**Table 5 Command Response Codes**

E00	No error (Correct command received and executed)
E01	Undefined Command
E02	Missing parameter
E03	Invalid syntax found in command string
E04	String of characters too long (>buffer limit)
E05	Parameter has too many digits after the decimal point
E06	Parameter outside the allowed range
E07	Failed Self Test
E08	Power too high
E09	Power too low
E10	Outside the operating wavelength range.

## Appendix 2.0 RS-232 connection and setup

1. The RS-232 connector on the rear panel of the DOP-201 is a DB9 male connector. Use a straight (not cross connected) RS-232 cable with DB9 female connectors to connect the DOP-201 to the control computer.

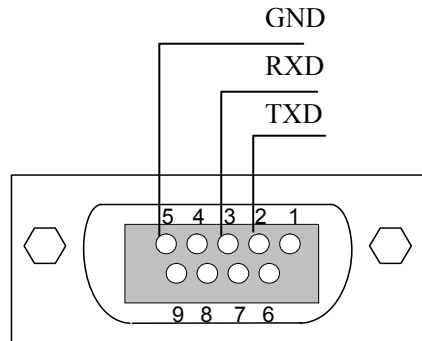

**Figure 8 RS-232 connector pin assignment on DOP-201 rear panel.**

2. Power on the instrument.
3. Set the RS-232 baud rate (Setup → System Setup → RS-232).
4. Select the command type and, for SCPI, command EOS (Setup → System Setup → Ending Char).
5. Send a command string to the instrument (See Appendix 1 for commands. Any program that supports RS-232 communication protocols can be used to send ASCII commands to the instrument. Many programming languages support serial communications, including Visual Basic, LabView and C.

### RS-232 settings:

RS-232 port uses asynchronous framing, 8 data bits, no parity bit, and 1 stop bit.

RS-232 baud rate: configurable. Default is 9600 bps.

## Appendix 3.0 USB connection and setup

USB drivers are included on the cd. They need to be installed before USB communication can be established. The first time the USB is used, insert the cd into the control computer.

Connect the DOP-201 to the control computer using a standard USB cable.

Power on the DOP-201.

### USB Driver Installation

The first time the computer detects a USB connection to the instrument, the driver may install automatically (Windows 7/8) or a "Found New Hardware Wizard" window may appear (Windows XP). If neither of these things occur, the driver can be located and installed using Device Manager.

1. Open Device Manager. Look for "FT245R USB FIFO" under "Other Devices". Right-click it and select "Update Driver Software".

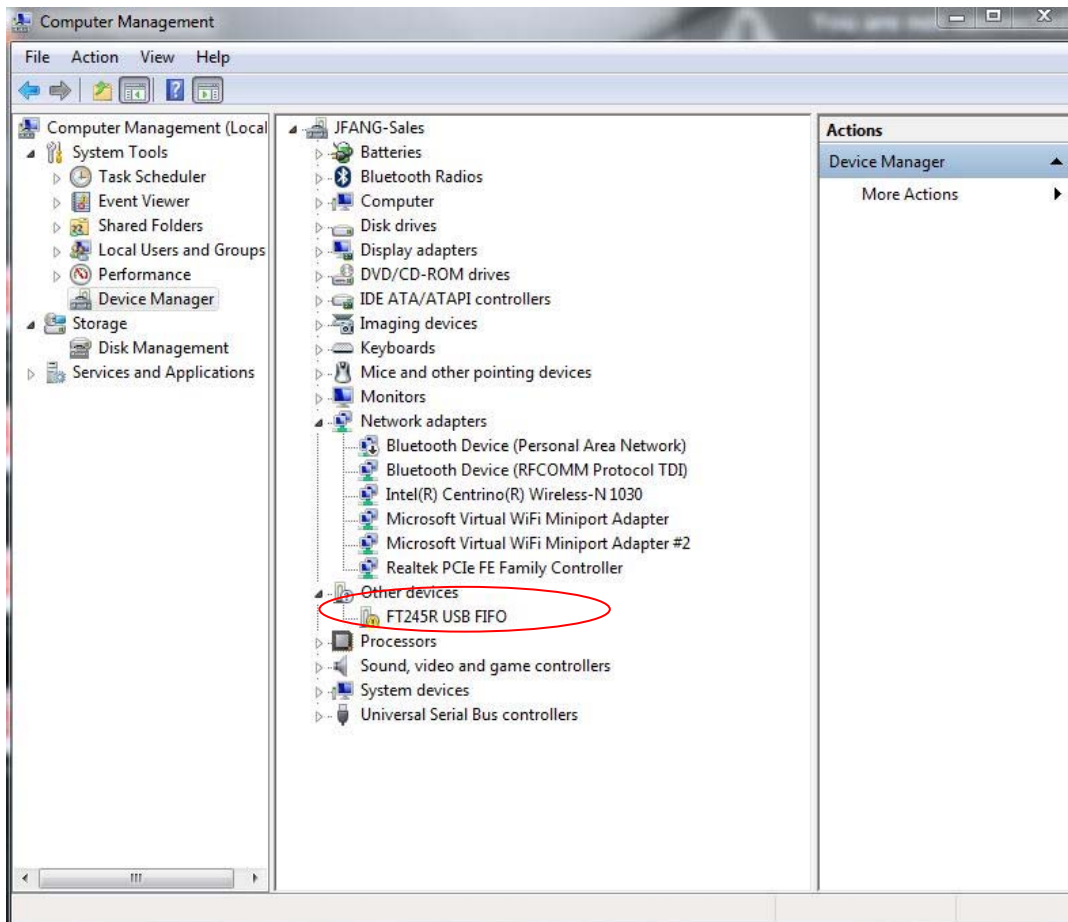

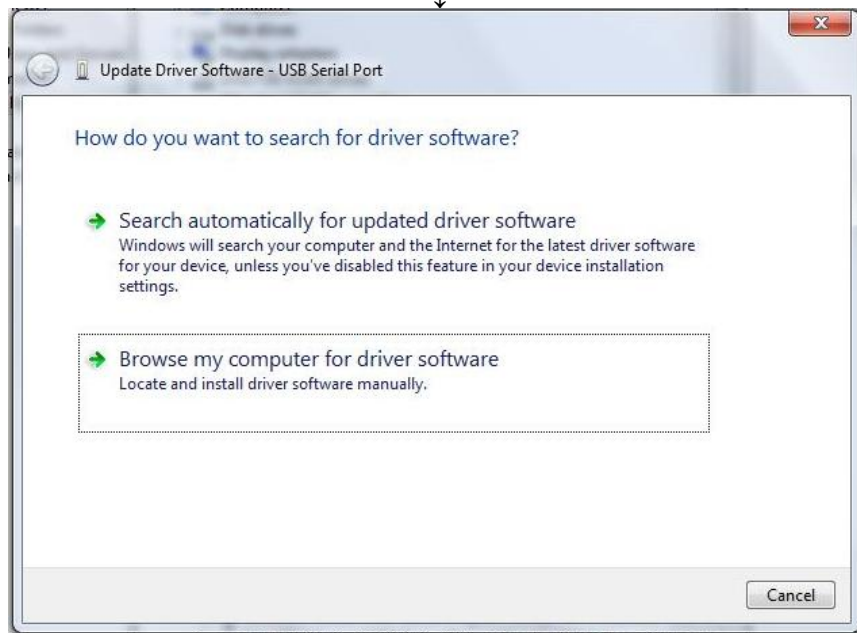

2. Select "Browse my computer for driver software":





3. Make sure that the software cd is inserted. Click "Browse", and navigate to the cd drive. For 64-bit systems, select the folder "ft245 WIN7 64bit". For all other systems, select the folder "VCP". Make sure the "include subfolders" box is checked. Click "Next".



4. The computer will ask whether to install the software. Click "Install".

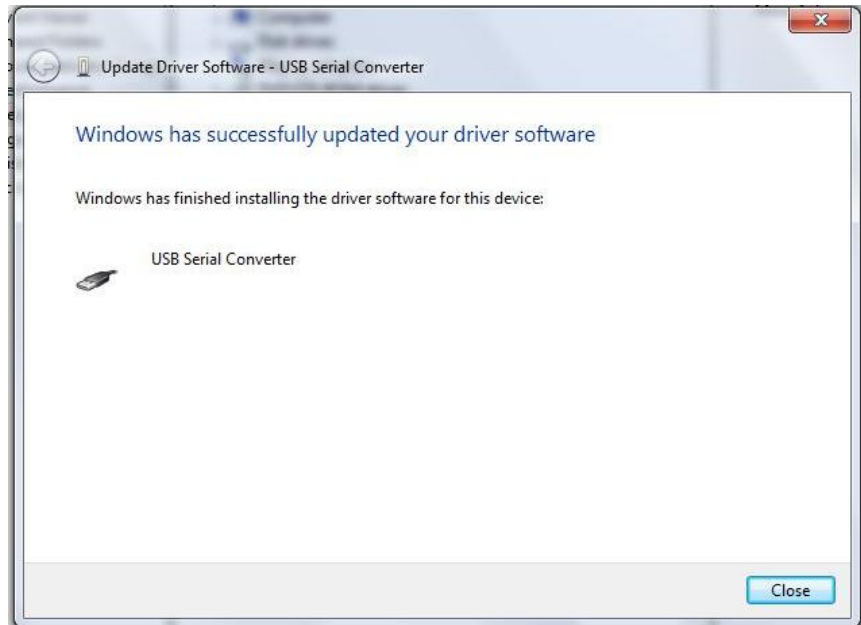

5. When the installation is finished, a "software successfully updated" message will appear. This completes the first part of the installation, during which the USB to serial converter is installed. The second part consists of the installation of the serial port driver.

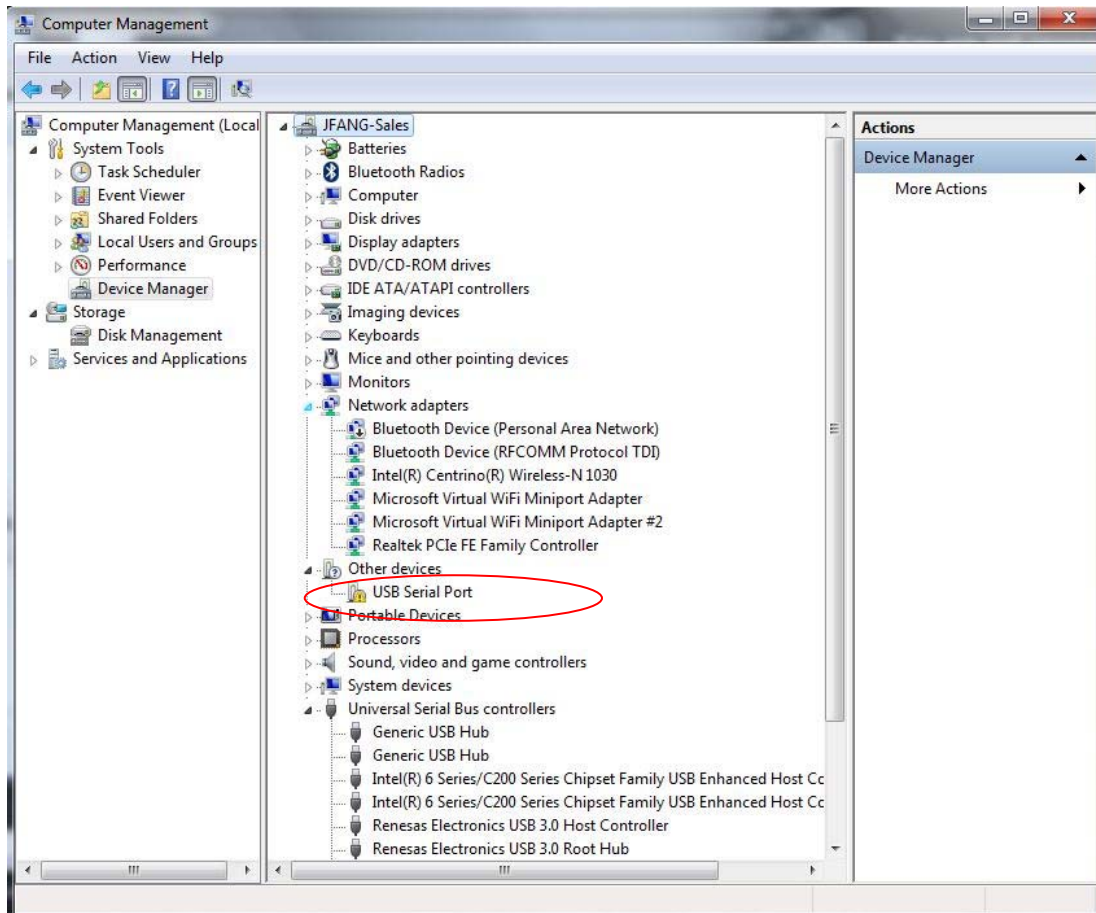

6. In Device Manager, "USB Serial Port" should now appear under "Other Devices. Right-click it and select "Update Driver Software". Follow the same procedure as described above to specify the driver location and install the driver until the completion window for the USB serial port appears:

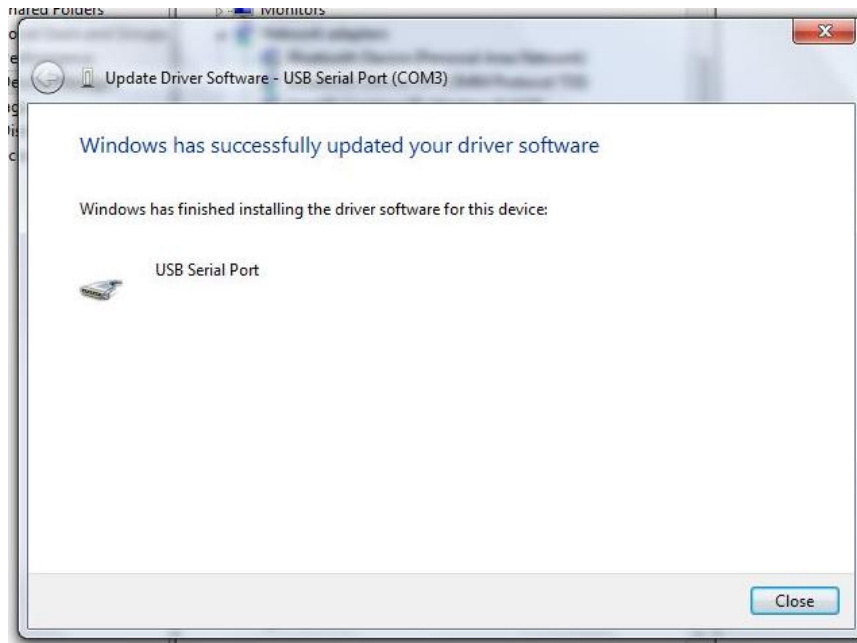

7. In "Device Manager", there should now be a USB Serial Port listed under "Ports (COM & LPT)":

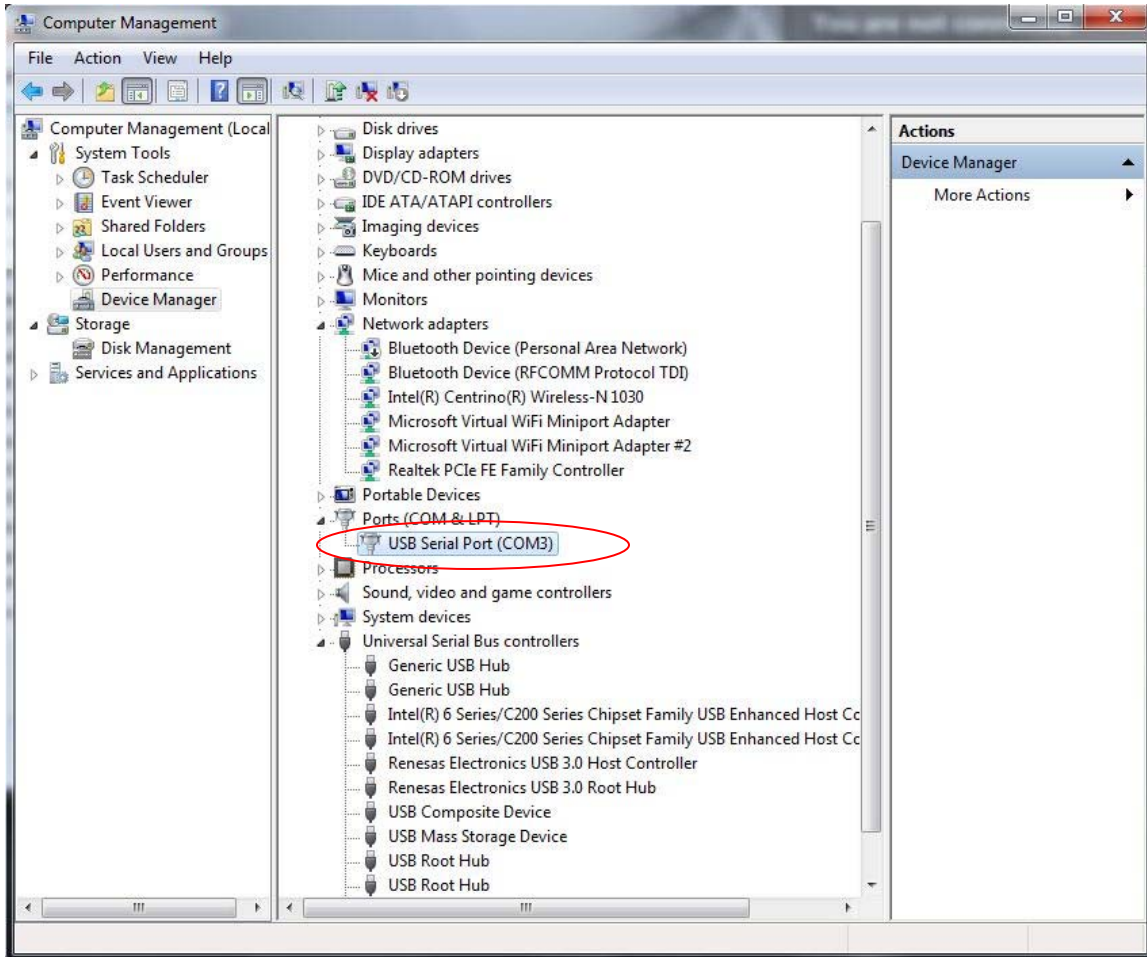

Note the port number that the DOP-201 is using (COM3, in this example).

The USB driver can drive more than one instrument, but the instruments will be connected under different port numbers.

## Appendix 4.0 Ethernet setup

There are two connection configurations for Ethernet control:

- a) **Static IP:** the administrator assigns the instrument a fixed IP address. In this mode the instrument can be directly connected to the control PC, as shown in Figure 9, or can be connected through a router. For a direct connection (Figure 9), a cross-linked network cable must be used. For a connection to a router, a standard straight-linked network cable would be used.
- b) **Dynamic IP:** the DHCP server assigns the instrument an available address when requested. Connect the instrument with a DHCP server (running on router or exchange server), as shown in Figure 10. For this configuration, a standard straight-linked network cable must be used.

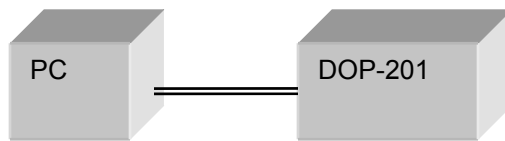

**Figure 9** Direct connection: DOP-201 to PC

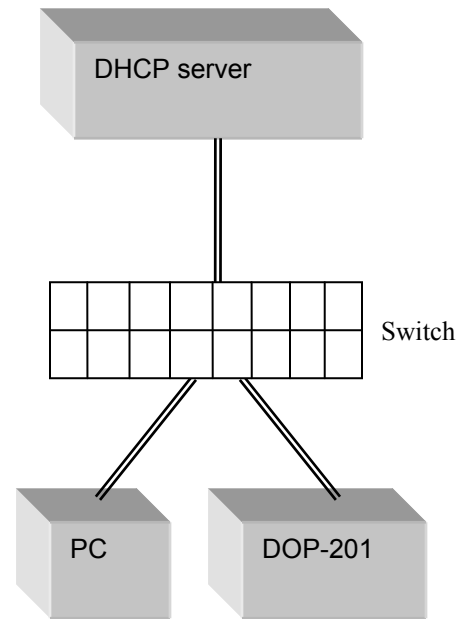

**Figure 10** Connection with DHCP server

Once the physical connections are established, the instrument's Ethernet configuration can be set up from the front panel.

DOP-201 Setup for Ethernet communication:

The "Dynamic IP" function in the setup menu sets the DOP-201 for dynamic IP addressing and requests a dynamic IP address from the DHCP server.

The "Static IP" function in the setup menu allows the user to set the static IP address, net mask, gateway, name server, and port. After these parameters are set, select "Yes" on the "Update Parameters?" screen to update the parameters and set the instrument for static IP addressing. See section 3.3 for a more detailed description.

The default Ethernet communication mode for the DOP-201 is dynamic IP addressing. When it is powered on, it will be in dynamic IP mode. However, it does not request a dynamic IP address from the server until the user selects the "Dynamic IP" function in the setup menu.

The DOP-201 saves static IP parameters (IP address, net mask, etc.) in nonvolatile memory, but since it powers on in dynamic IP mode, it is still necessary to select the "Static IP" function in the Setup menu, scroll through the setup screens, and select "Yes" on the "Update Parameters?" screen in order to switch the instrument to static IP mode, even if there are no parameter changes.

For static IP control, the net mask and gateway for the instrument should be the same as those for the control computer. The first 3 groups of numbers in the IP address should be the same as those for the control computer (192.168.2, for example). The last number can be any available number, but cannot be the same as the IP address of the control computer. The range of numbers is 1 to 254. If the computer's IP address is 17, for example, the user can set the IP address for the DOP-201 to any number in the range 1-254 except 17.

For static IP control, make sure that the control computer is also set to use a static (defined) IP address (check the TCP/IP properties to find the computer's Ethernet setup information).

For dynamic IP control, make sure that the control computer is set to obtain its IP address automatically. This information is also under TCP/IP properties.

- To connect the instrument directly to a PC, use a PC to PC cable. To connect the instrument to a LAN, use a standard network cable.

## Appendix 5.0 GPIB setup and control

### Setting the GPIB Address

To set the instrument's GPIB address:

Setup → System setup (option 7) → GPIB address (option 7a)

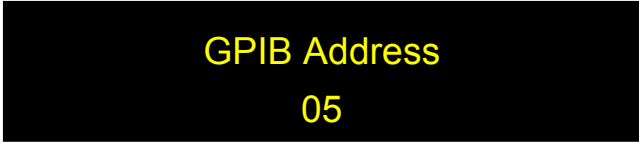

GPIB Address  
05

Rotate the wheel to change the GPIB address and press ENTER to save the new setting. The address is retained in memory after power-off.

Range: 1-30

Default: 5

### GPIB control

Connect the instrument to the computer with a GPIB cable. After determining/setting the DOP-201's GPIB address, enter it in the communication program being used. The instrument will then be ready to receive commands. The command lists, responses, and error codes are given in Table 1 through Table 5 in Appendix 1.

To ensure proper communication, use a GPIB cable that is fully compatible with the IEEE 488.1 standard. All GPIB/IEEE 488 interface connections must be made before turning on the instruments.